



INSTALLATION MANUAL

Stage1 621





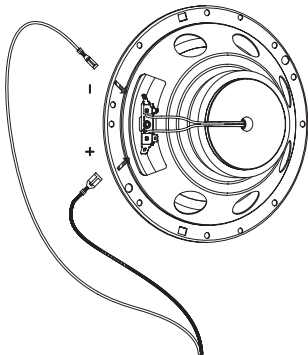
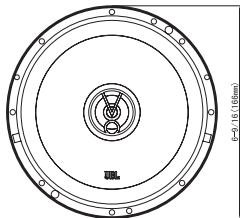
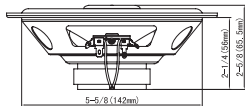

Stage1 9631

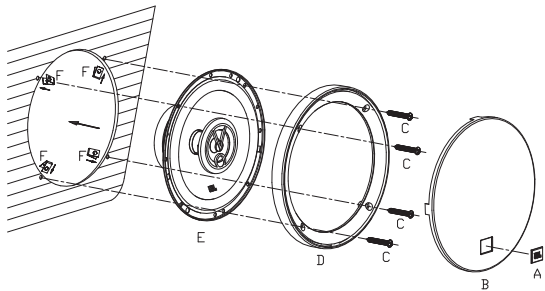
Stage1 601C

Stage1 621





<p>A</p>  <p>2x</p>	<p>B</p>  <p>2x</p>	<p>C</p>  <p>8x</p>	<p>D</p>  <p>2x</p>	<p>E</p>  <p>2x</p>	<p>F</p>  <p>8x</p>
--	--	--	--	--	--

Specifications

- Type: 6-1/2" (160 mm) Two Way Car Speaker
- Power Handling: 35Wrms, 175W peak
- Sensitivity (@ 2.83V): 90 dB
- Frequency Response: 55 Hz – 20 kHz
- Nominal Impedance: 4 ohms



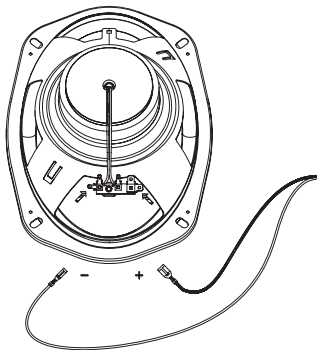
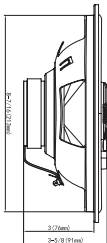
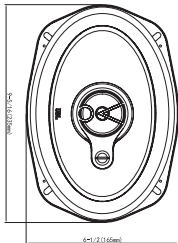
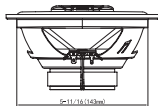

Thiele-Small Parameters

- BL (Tm): 2.408
- DCR (ohm): 3.2
- Mms (g): 8.552
- Sd (cm²): 128.68
- Cms (μm/N): 411.426
- Vas (l): 9.674
- Fs (Hz): 85
- Qes: 2.515
- Qms: 3.616
- Qts: 1.483
- Crossover Point: 4.2 kHz

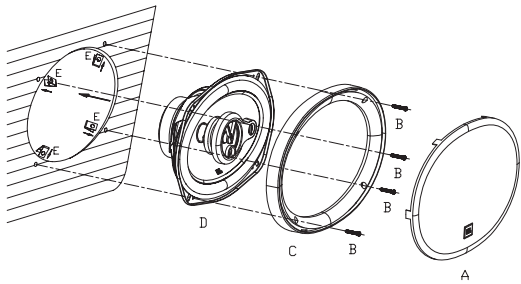
Stage1 9631





<p>A</p>  <p>2x</p>	<p>B</p>  <p>8x</p>	<p>C</p>  <p>2x</p>	<p>D</p>  <p>2x</p>	<p>E</p>  <p>8x</p>
--	--	--	---	--

Specifications

- Type: 6" x 9" (152mm x 230mm) Three Way Car Speaker
- Power Handling: 60Wrms, 300W peak
- Sensitivity (@ 2.83V): 89dB
- Frequency Response: 50 Hz – 21 kHz
- Nominal Impedance: 4 ohms

Thiele-Small Parameters



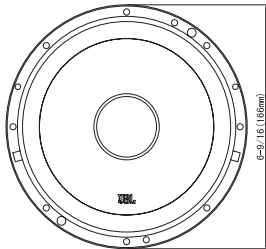
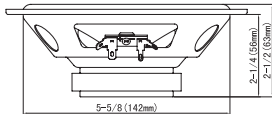

- BL (Tm): 3.192
- DCR (ohm): 2.3
- Mms (g): 17.316
- Sd (cm²): 213.565
- Cms (μm/N): 311.651
- Vas (l): 20.184
- Fs (Hz): 70
- Qes: 1.683
- Qms: 3.878
- Qts: 1.174
- Crossover Point: 3.8 kHz

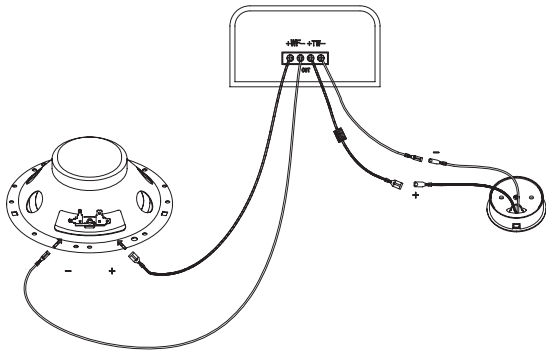
Stage1 601C

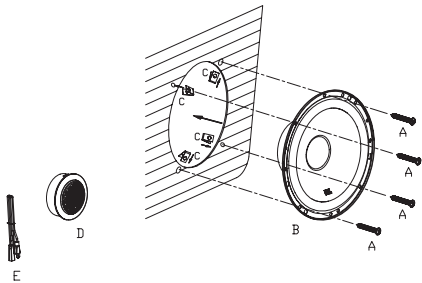





<p>A</p>  <p>8x</p>	<p>B</p>  <p>2x</p>	<p>C</p>  <p>8x</p>	<p>D</p>  <p>2x</p>	<p>E</p>  <p>2x</p>
--	--	--	---	--

Specifications

- Type: 6-1/2" (160mm) Two Way Component System Car Speaker
- Power Handling: 40Wrms, 200W peak
- Sensitivity (@ 2.83V): 90dB
- Frequency Response: 55 Hz – 20 kHz
- Nominal Impedance: 4 ohms

Thiele-Small Parameters

- BL (Tm): 3.588
- DCR (ohm): 3.2
- Mms (g): 11.01
- Sd (cm²): 128.68
- Cms (μm/N): 348.261
- Vas (l): 8.189
- Fs (Hz): 85
- Qes: 1.398
- Qms: 3.618
- Qts: 1.008
- Crossover Point: 6.0 kHz



HARMAN International Industries,
Incorporated, 8500 Balboa
Boulevard, Northridge, CA 91329
USA

© 2019 HARMAN International
Industries, Incorporated. All

rights reserved. JBL is a trademark of HARMAN International
Industries, Incorporated, registered in the United States and/or
other countries.

Features, specifications and appearance are subject to change
without notice.